

## 1. Summary

Steanes S304 valve amplifier. S.N. 2467. Mar 2012

Two input (MIC, PU) channel PA amplifier. 6N8 MIC preamp, 6N8 mixer. 6SN7 triode dc coupled to cathodyne triode. 6V6 PP cathode biased; OT and screens to B+. 2Ω feedback to 6SN7 triode cathode. 5V4G rectifier; capacitor input B+; choke to preamps; 50R 3W in series with each diode. Input volume controls; bass and treble tone. Humdinger.

Output Transformer	? (A&R) Type No. ? 15W nominal 8,000Ω PP. Output winding sections 0,2,100R,250R,500R,750R.
Power Transformer	A&R 1672 or 2132. 315-0-315V ?mA; 5V 2A ( BLK,BLK ); 6V3 3A (GRN,GRN); 0-110-220-240-260V
Choke	dated 26 Jun 1951 (Rola style CH22)
POTs	IRC RC2, BD2; .
Caps	Ducon cans & axials; Ducon HS foil.
Resistors	early carbon comp and Merlin WW.
Valves	6V6GT x2: Radiotron LJ; Philips 6SN7 x1: 6N8 x2: MTC TE 5V4G x1: Philips N16 , xxx A1

Very good general condition. Side handle chrome poor. MIC input socket replaced by ¼" socket. Unconnected 4-pin remote switching socket. Choke dated 1951. Steanes changed name to Philips circa 1955-6. Likely made circa 1952.

Issues: wax and electrolytic caps. Chassis grounding. Speaker switching. No mains switch. Added series resistance to diodes. 6SN7 V3b heater- cathode voltage.



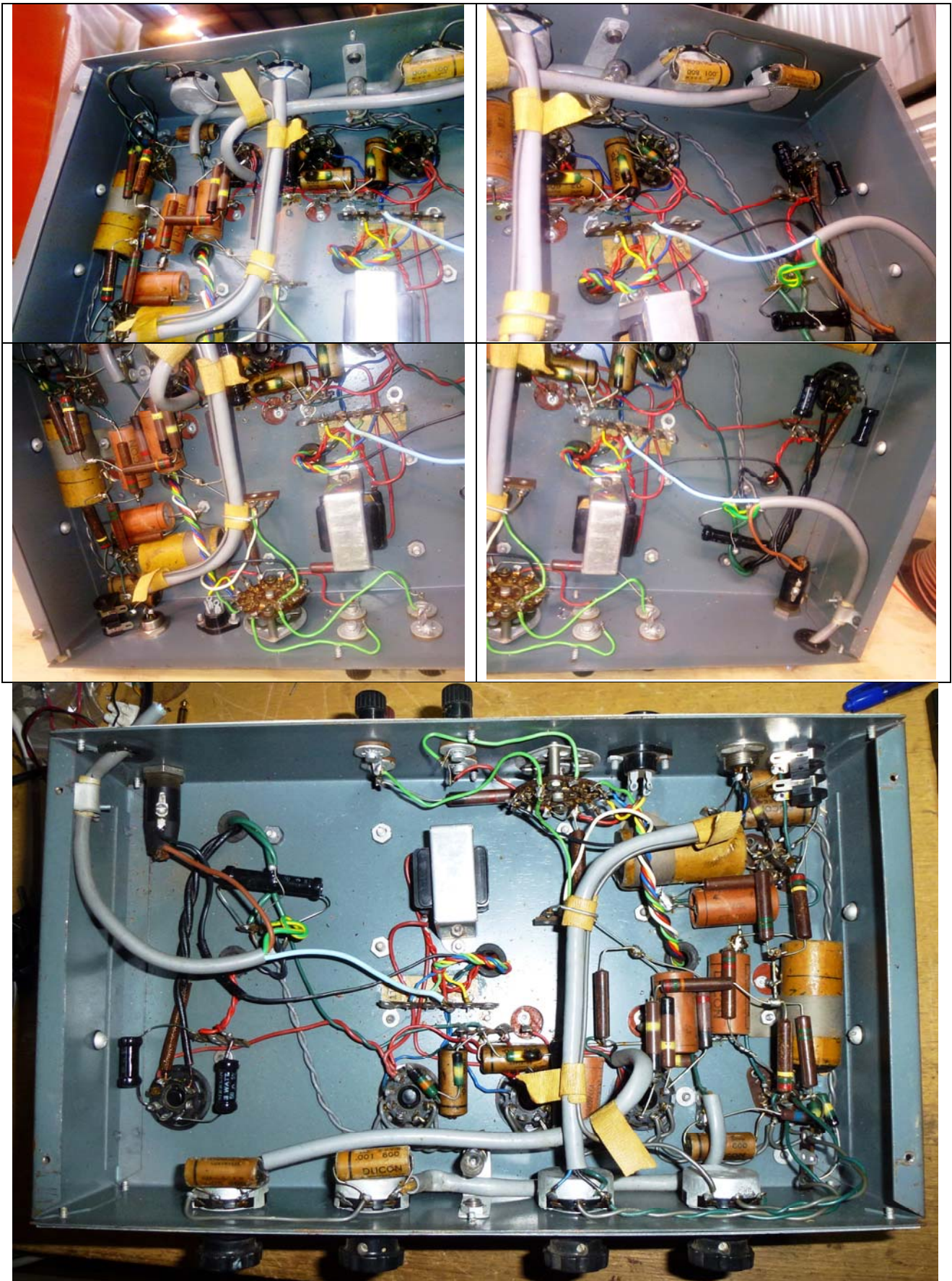

## 2. Modifications

- Replaced impedance switch with 6.5mm speaker socket.
- Replaced Inter Conn banana socket with AC mains switch.
- Replaced electrolytic and foil caps.
- Added series 1N4007s with 5V4G diodes.
- Moved PU pot to post 6N8 mixer.
- 47k grid stoppers on V2, V3a and V3b.
- Removed feedback (winding used for output).
- 660VDC MOV protection on each OT half-primary
- 270 $\Omega$  screen stoppers on 6V6.
- ¼" socket on front panel for input.
- Hardwired 2 $\Omega$  winding in series with the 500-750 $\Omega$  section to present 14 ohm output section to ¼" socket – red wire end to ground
- Sense voltages for ground, common cathode voltage and individual 6V6 cathode sense resistors to 4-pin socket.

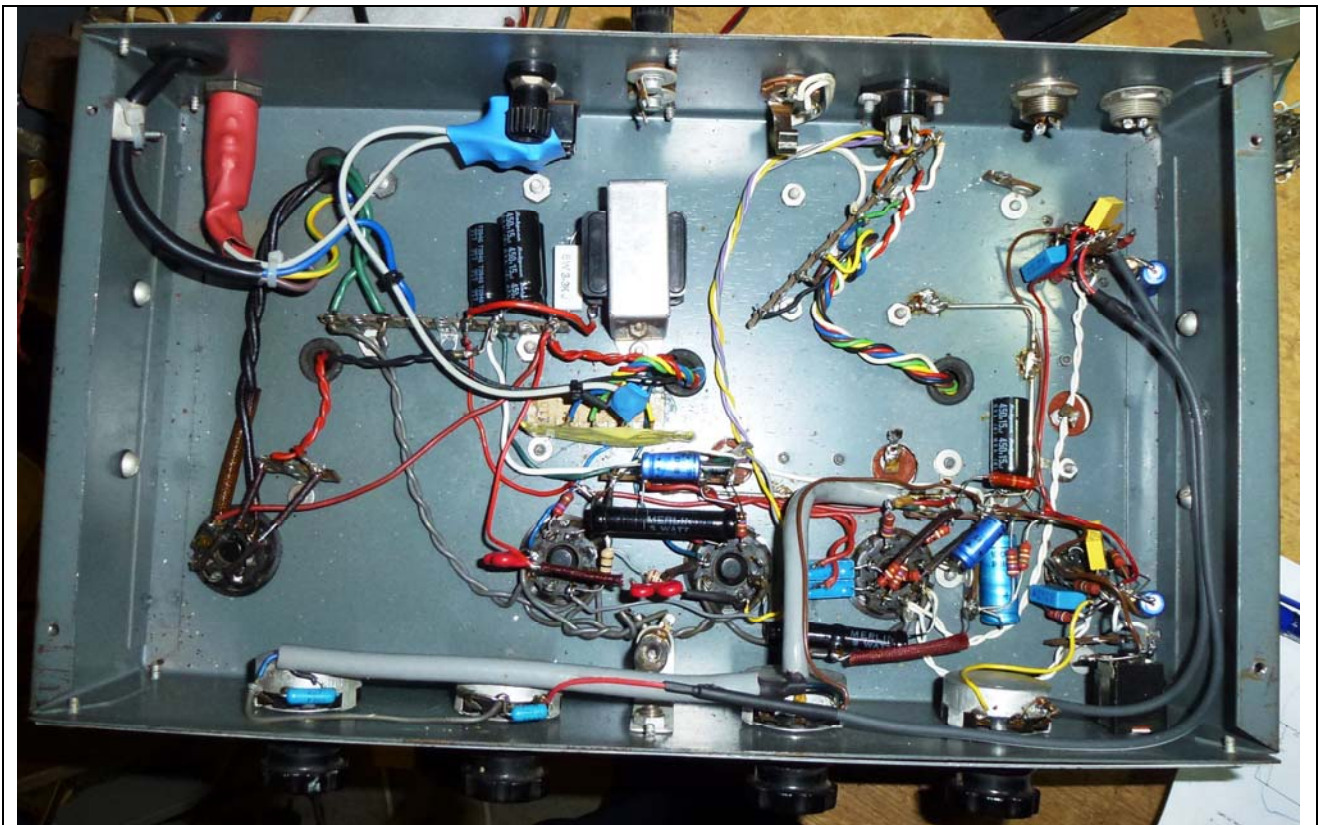

### 3. Measurements

Megger tested 1kV on PT mains and secondary, and OT primary – all ok.

Voltage rail regulation.

Rail	No load	240VAC, idle	240VAC, idle
VS1		350	350 (4.7Vac)
VS2		340	308
VS3		200	193
PP cathode		20V (35mA, 39mA)	18V 10.5+10.5W
Heater			
Sec HT	315-0-315V		

240V primary DCR=20Ω. 118Ω and 124Ω secondary HT halves.

Choke: 570Ω dc resistance; 12H @ 16mA<sub>dc</sub>; 10.8H @ 45mA<sub>dc</sub>; 6.8H @ 73mA<sub>dc</sub>; most likely CH22 from Rola.

12VAC 50Hz nominal applied to output transformer

Winding	Voltage rms	Turns ratio; Impedance for 8K pri; Spec level; Notes		
Pri P-HT: BLU to BLU				
Sec: BLK to GRN		3.51; 650 Ω;	750Ω;	1000T
Sec: BLK to BLU		3.88; 530 Ω;	500Ω;	906T
Sec: BLK to YEL		5.63; 250 Ω;	250Ω;	625T
Sec:BLK to BRN		9.6; 87 Ω;	100Ω;	366T
Sec:WH to RED		65.4; 1.9 Ω;	2Ω;	54T

Output transformer primary DC resistance: 66+67Ω  
8kΩ plate-to-plate.

The 500-750 section is effectively 6 ohm (94 turns; 9.4%).

The 2Ω winding in series with the 500-750 section is effectively 14 ohm (148 turns; 15%).

Eg. 16Ω speaker for 15% of turns.

6.3V heater loading: 2x 0.45A, 1x 0.6A, 2x 0.3A = 2.1A

5V heater loading: 1x 2A = 2A

The power supply is typical full-wave rectified type using double diode 5V4G and a 315-0-315 VAC centre-tapped secondary, which is just above the max specified voltage for capacitor input. The effective input resistance of the transformer is about  $20\Omega \times (315/240)^2 + 120\Omega (+ 50\Omega) = 155\Omega$ . An effective resistance of 100Ω allows up to 40uF at 375VAC, so 30uF at 315VAC requires no added resistance. VS1 is about 430VDC no load.

V1 stage gain about 50x for 10V output. V2 stage gain about 25x for 10V output.

V3 stage gain about 15x for 5V output to 6V6 grid, from vol wiper – overload at about 23Vrms on 6V6 grid – no 6V6 in circuit.

Output in to 17Ω cranked out at about 14W.

### 3.1 Splitter stage

A dc coupled driver to cathodyne PI circuit using a 6SN7.

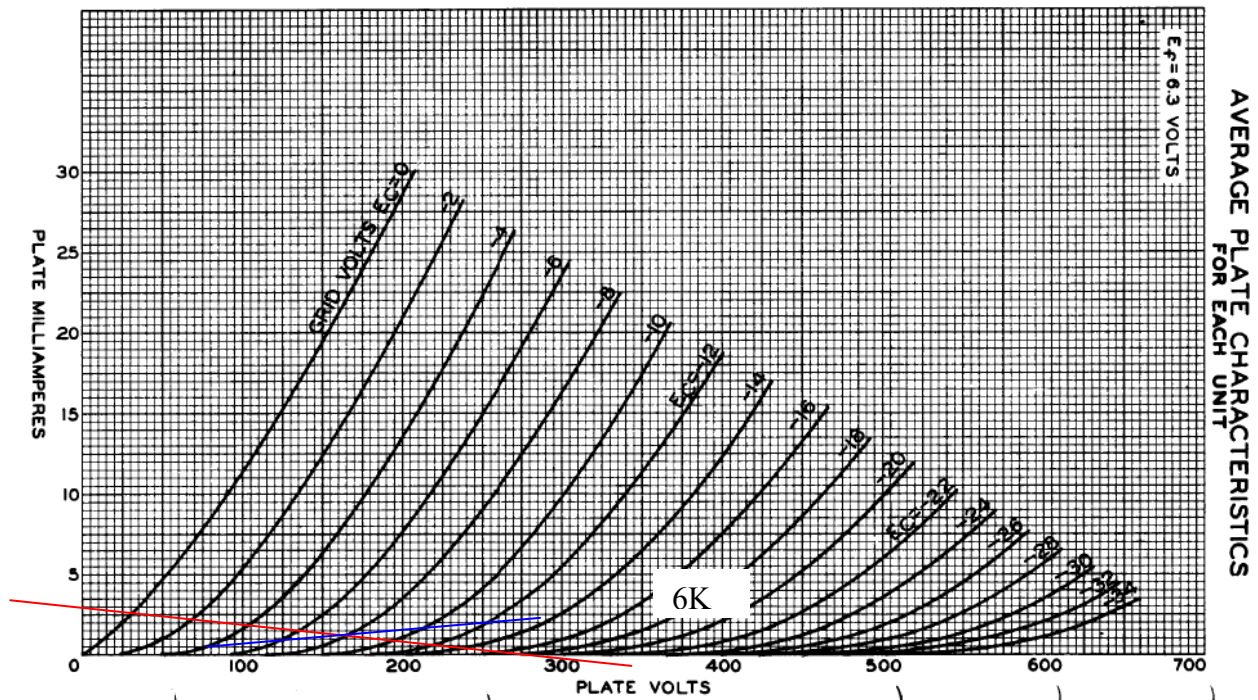

### 3.2 Output Stage

In this Class AB push-pull UL output stage, one 6V6 tube is pushed into conduction and the other tube is pulled into cutoff, and there is a region of overlap where both tubes conduct equivalent levels of current. The cathodes are biased with a common resistor to ground. The OT presents about 85k $\Omega$  impedance plate-to-plate OPT for 16 ohm speaker, presents each tube with a 2.1k $\Omega$  load impedance for larger signal currents, and 4.2k loading for small signal levels.

Determining a suitable bias current level is not an empirical design approach, rather it is based on the following recommendations:

- Start with the lowest bias current possible (ie. most negative grid bias voltage), and based on listening tests, increase the bias current until the sound character is acceptable, but:
- use the lowest possible bias current level, as this generally increases the life of the tubes, and decreases the chance of operating at excessive plate dissipation; and
- keep the bias current level below 70% of the recommended design max plate dissipation (ie. <9W); and
- assess the dynamic loadline to see if it moves into region of increased plate dissipation.

As the output loading increases, the supply voltage VS1 sags only a few volts from 350V, due to supply regulation. Plate DC voltage will be lower than VS1 by an amount up to ~27V; ie. OPT half resistance of about 67 $\Omega$  with a peak current of up to about 0.1A, and cathode bias of 20V.

The screen voltage will correspondingly sag. Screen current level increases as Vg approaches 0V, possibly to over 40mA, with an additional drop across the screen stopper resistor. Screen voltage sags to about 308-(15mA $\times$ 270)-20= 284V at start of overdrive.

The maximum output valve bias current allowed is dependant on the maximum recommended plate dissipation of 12W for the 6V6:  $I_{bias(max)} = P_d / V_b = 12W / 300V = 40mA$ .  $I_{bias(nom)} = 0.7 \times 12W / 300V = 28mA$ .

The common cathode resistance is about  $18V / (33mA + 33mA) = 275\Omega$  at 1.2W.

The nominal output power of the amplifier will then be:

$$(I_{max})^2 \times R_{pp} / 8 = 0.09 \times 0.09 \times 8.5k / 8 = 8.5W$$

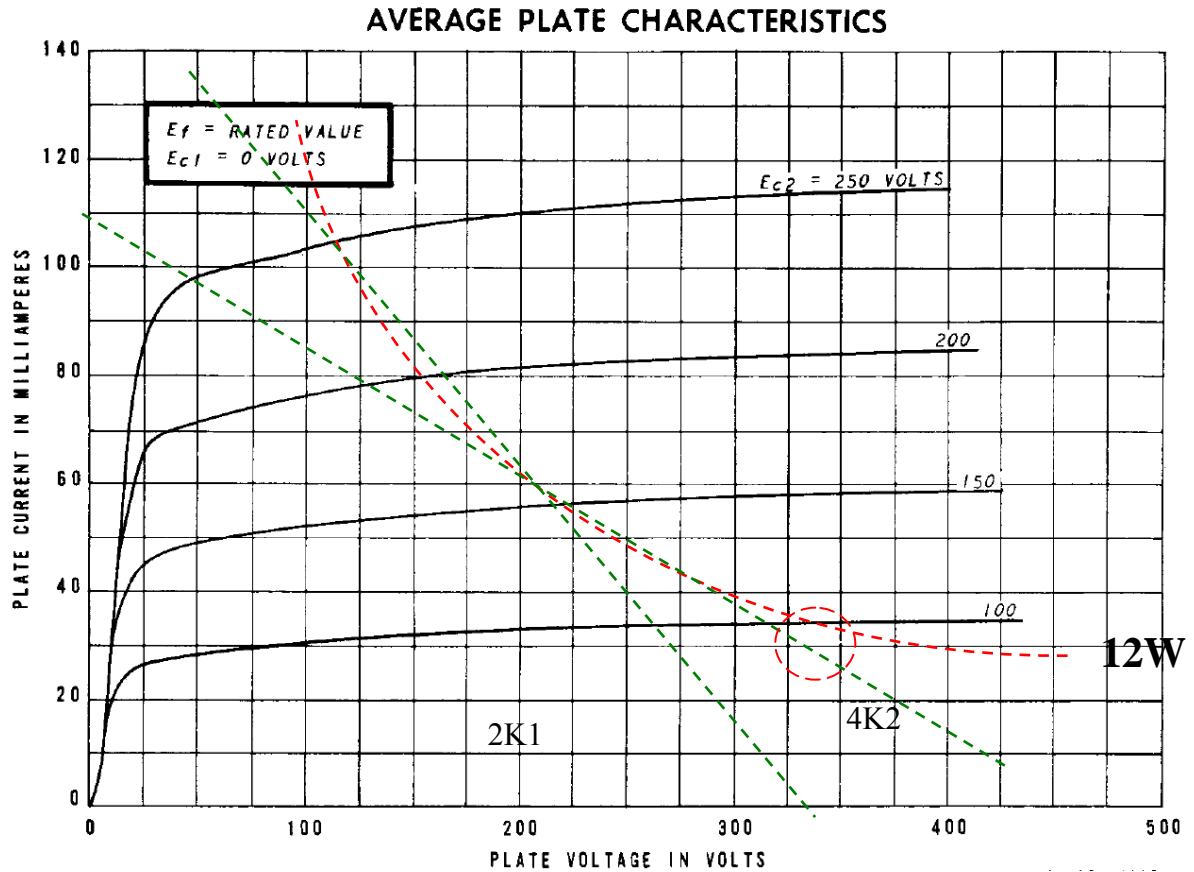

AVERAGE PLATE CHARACTERISTICS

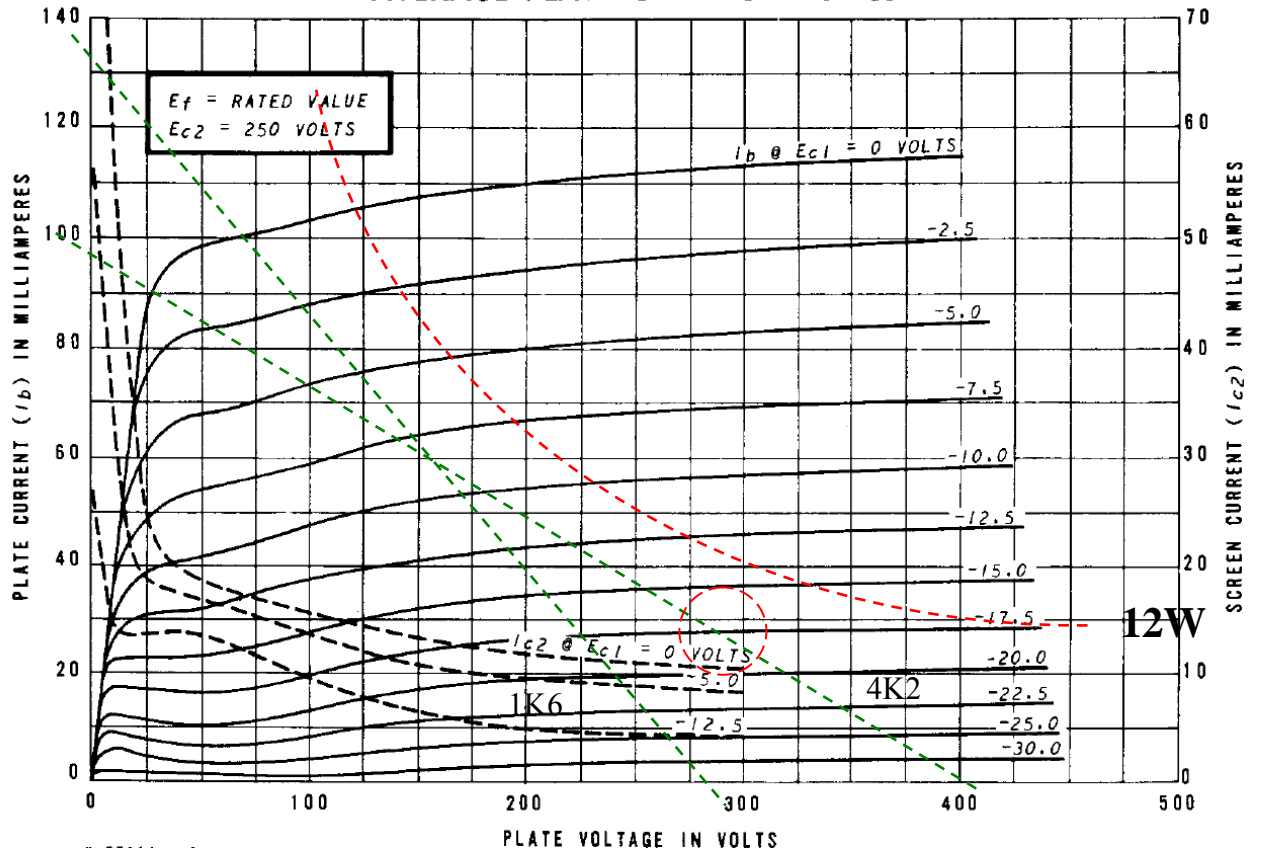

**3.3 Power Supplies**

The power supply is typical full-wave rectified type using double diode 5V4 and a 315-0-315 VAC centre-tapped secondary. With a capacitor input filter, this gives about 430 VDC at low load, reducing to about 350 VDC at 100mA.

# STEANE'S SOUND SYSTEMS S304 AMPLIFIER

S.N. 2467

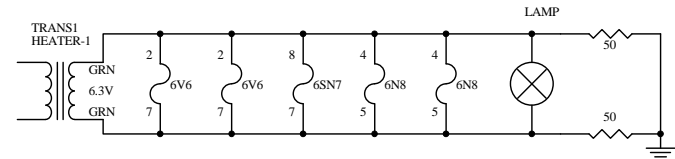
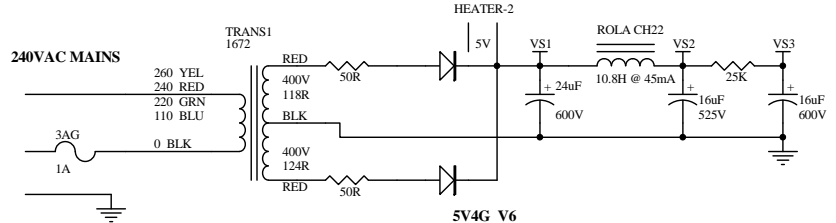
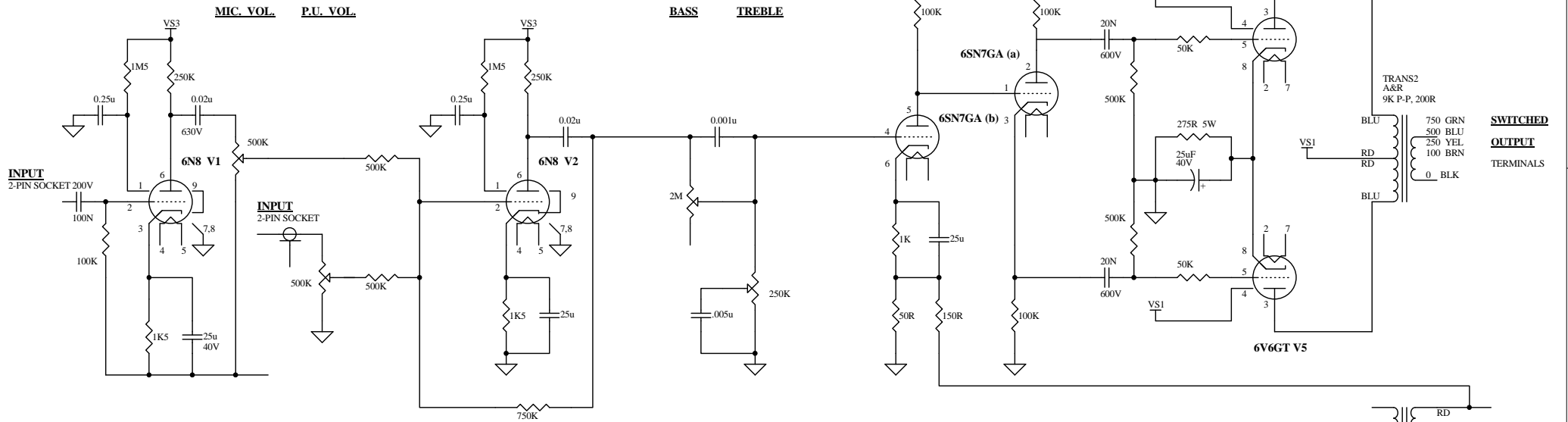

Replacement Part \*\*  
V1, V2, V3 on shock mount sockets

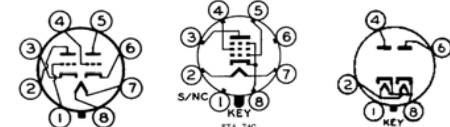

VOLTAGE RAILS		VALVE	QTY
RAIL	NO LOAD	6N8	2
VS1	V	6SN7	1
VS2	V	6V6	2
VS3	V	5V4	1
HEATER-1	V		
HEATER-2	V		

Title		
Size	Number	Revision
B		
Date:	22-Apr-2013	Sheet of
File:	\\tsclient\C\Program Files\Design Explorer\90511\Projects\Amplifier Modules.ddb	



**STEANE'S SOUND SYSTEMS S304 AMPLIFIER - MODIFIED**  
**S.N. 2467**

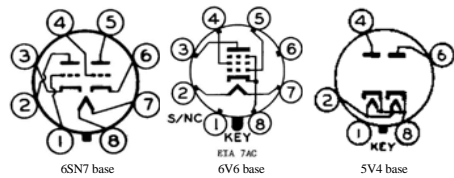
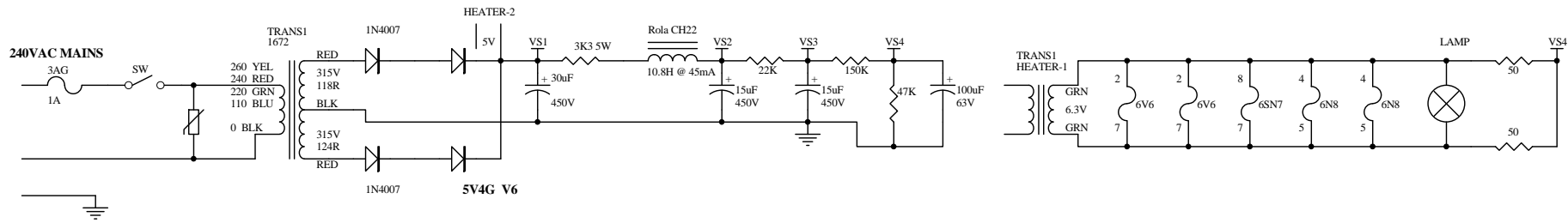
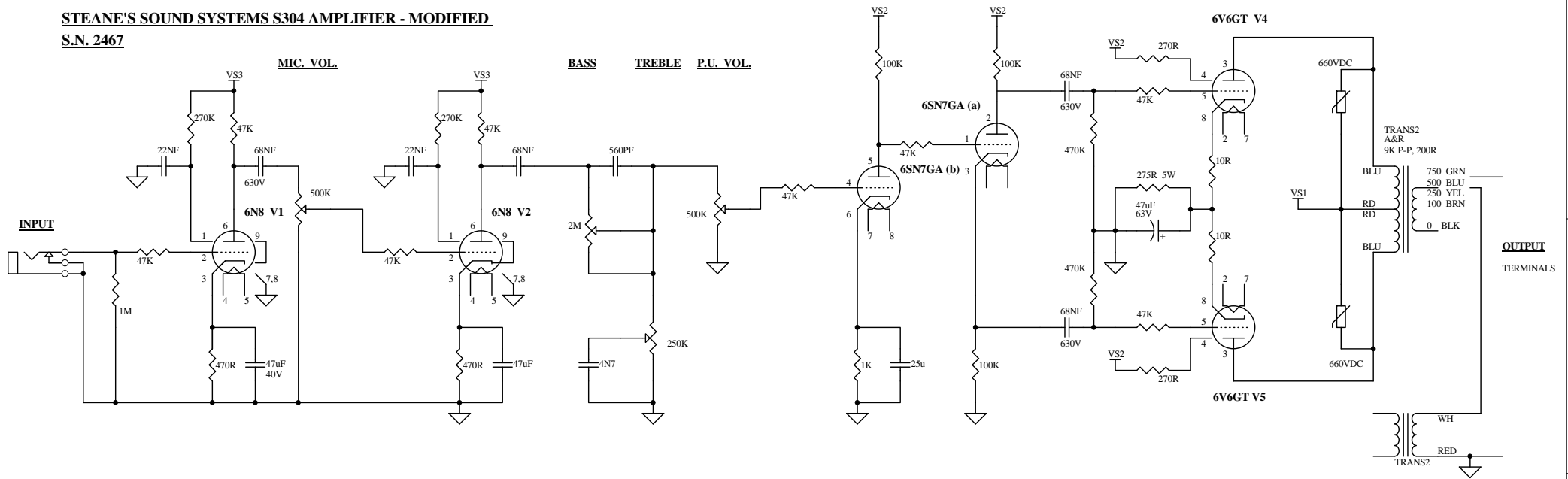

VOLTAGE RAILS		VALVE		QTY
RAIL	NO LOAD	6N8		2
VS1	350V	6SN7		1
VS2	308V	6V6		2
VS3	193V	5V4		1
Vcathode	18V			
Cathodes	33mA+33mA			

Title		
Size	Number	Revision
B		
Date:	16-May-2013	Sheet of
File:	\\tsclient\C\Program Files\Design Explorer\906151\Projects\Amplifier Modules.ddb	9 of 10

# FIRST AGAIN!



*Magrath's have installed Australia's first*

## AUDIO PANEL

ENABLING YOU TO  
CHOOSE AN AMPLIFIER,  
PICK-UP, OR MICROPHONE  
AT THE FLICK OF A SWITCH!

featuring STEANES SOUND EQUIPMENT

Gone is the old bug-bear associated with purchasing sound equipment by appearance. Now at Magrath's the amazing AUDIO PANEL interconnects sound equipment so that, at the flick of a switch, you can hear any combination of STEANES SOUND EQUIPMENT and choose the amplifier, pick-up, or microphone you prefer. It's NEW . . . it's REVOLUTIONARY . . . It's thoroughly EFFICIENT! See and hear a demonstration at MAGRATHS'!

Latest  
American Innovation  
"Merry-Go-Sound"  
. . . it's installed at  
**MAGRATHS'**  
See the  
actual photograph above!

# MAGRATHS'

Phone  
Cent. 4414

208 LITTLE LONSDALE ST.,  
MELBOURNE